



S series **SC8131** Stereo Network Camera



People Counting · 3D Depth Technology · High Accuracy · Bi-Directional

VIVOTEK's SC8131 is a stereo counting camera, armed with VIVOTEK's 3D Depth Technology and video surveillance functionality, providing 2-Megapixel real-time precise tracking video and high accuracy counting up to 98%. The stereo camera generates data information such as people counting, flow path tracking that applied to in store layout improvement, promotional evaluation, staff planning, and the control of service times, providing business owners key metrics to effectively make operating decisions and increase ROI.

Mounted over a store entrance, the dual-lens camera enables the stereo vision to accurately track the 3D positions of objects moving across the field of view. Adults or children, single

individuals or groups, can be distinguished from non-human objects such as shopping carts and strollers, providing accurate counting analytics even at the busiest and most congested times.

Furthermore, seamless integration with VCA (video content analysis) reports in VIVOTEK's VAST, the metadata is displayed in comprehensive graphs and line charts, making the SC8131 ideal for retail analytics. The computation of height disparity data is embedded in the stereo camera, instead of sending video streams to a dedicated computer running a separate analytics software. The counting solution saves bandwidth and reduces the risk of data loss in the event of network or power disruption.

Features

- VIVOTEK's 3D Depth Technology
- High Accuracy Rate up to 98%
- Local Storage Data for Counting Report
- Easy Installation and Configuration
- Seamless Counting with VAST CMS

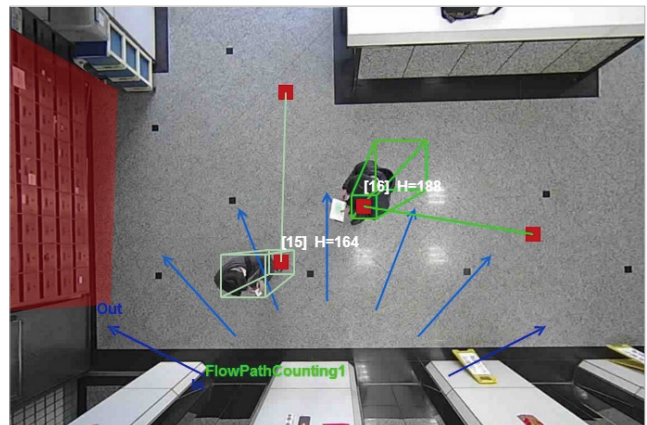

Benefits

Precision

- VIVOTEK's 3D Depth Technology
- Up to 98% counting accuracy rate
- Real-time data (system/counting/daily reports; time/region reports)



Efficiency

- Object tracking path
- Filter carts, children and strollers
- Bi-directional counting on definable flow
- Detection of U-turns to avoid double counting
- Not Influenced by shadows, reflections or glare conditions

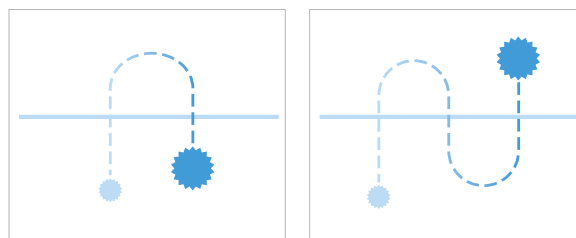

Counting: 0

Counting: 1

Video Security

- Video surveillance (viewing and recording)
- Multiple video streaming
- Remote management
- Seamless integration with VAST CMS

Easy Installation

- Discreet ceiling mount
- Compatible with 4"x2" electrical box

Technical Specifications

Model	SC8131 (F2): f = 2 mm SC8131 (F4): f = 4 mm SC8131 (F6): f = 6 mm
System Information	
CPU	Multimedia SoC (System-on-Chip)
Flash	256 MB
RAM	512 MB
Camera Features	
Image Sensor	1/3" Progressive CMOS
Maximum Frame Rate	15 fps @ 2560x960
On-board Storage	MicroSD/SDHC/SDXC card slot
Video	
Compression	H.264 & MJPEG
Maximum Streams	3 simultaneous streams
Report Format	JSON/XML/CSV
General	
Connectors	RJ-45 for Network/PoE connection DI/DO USB 2.0 (Only as a power bank, not for data transmission) MicroSD Slot
LED Indicator	System power and status indicator
Power Input	IEEE 802.3af PoE Class 3
Power Consumption	PoE: Max. 12.95W USB: Max. 300mA
Dimensions	160 (D) x 70 (W) x 38 (H) mm
Weight	396 g

Safety Certifications	CE, LVD, FCC Class B, VCCI, C-Tick, UL
Operating Temperature	Starting Temperature: 0°C ~ 40°C (32°F ~ 104°F) Working Temperature: -10°C ~ 40°C (14°F ~ 104°F)
Warranty	36 months
Installation	
Installation Height	SC8131 (F2): 240~500 cm (7.9~16.4') SC8131 (F4): 500~800 cm (16.4~26.2') SC8131 (F6): 800~1000 cm (26.2~32.8')
System Requirements	
Operating System	Microsoft Windows 8/7/Vista/XP/2000
Web Browser	Mozilla Firefox 7~43 (streaming only) Internet Explorer 9/10/11
Other Players	VLC: 1.1.11 or above QuickTime: 7 or above
Included Accessories	
Others	Quick installation guide, mounting bracket, screw pack
Dimensions	



ND9312

H.265 8CH Embedded NVR

H.265 • 4K Display • Fisheye Dewarp • Web Plugin Free •
VIVOCloud • Trend Micro IoT Security • ONVIF

- H.265 Compression Technology
- Up to 8 Channel IP Camera Input
- HDMI Video Output up to 4K Resolution
- 1 x 3.5" SATA HDD
- Up to 8MP Camera Live View and Playback
- Trend Micro IoT Security
- Multiple Browsers Supported: IE, Chrome, and Firefox on both Windows & macOS
- Live and Playback Fisheye Dewarp
- VIVOCloud App & Portal for 24/7 Viewing
- Compact Size with Fanless Design



Highlight Features

Better Video Quality with Lower Bandwidth

With H.265 standard and VIVOTEK's Smart Stream technology, VIVOTEK NVR is not only able to provide the high quality video, also save the usage of network bandwidth and recording capacity more than regular H.264 standard.

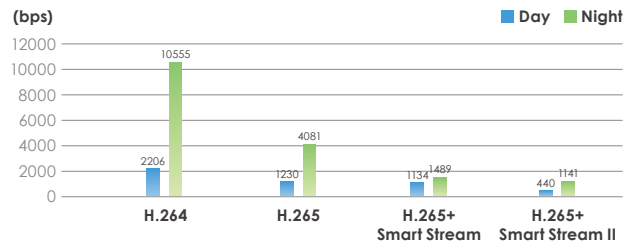

4K IP Camera Video Input and 4K Local Video Output

Supporting 4K IP camera video input and 4K local video output, VIVOTEK's NVR can provide users extra high definition video resolution ensuring they will never miss a single detail in both video monitoring and recording.



4K Resolution

Fisheye Dewarp

VIVOTEK's NVR offers both LiveView and Playback modes for one fish-eye network camera simultaneously. They also provide multiple fisheye de-warp display modes, including 1O, 1P, 1R, 1O3R, 1O8R, allowing users to monitor any angle, or to enjoy precise detailed images for a total surveillance experience.

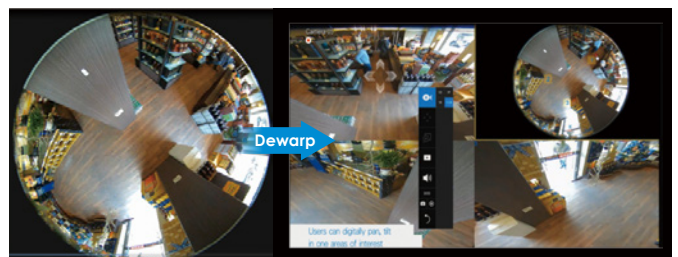

Chrome & Firefox Now Supported

Support for plug-in free web browsers enables users with direct web viewing/setting on IE, and now also on Chrome and Firefox web browsers, for both Windows and macOS.



Highlight Features

Trend Micro IoT Security

In collaboration with industry-leading cybersecurity software partners, VIVOTEK focuses on making network security products and software that meet industry protocols as well as constantly developing shields to increase your protection from various cyberattacks. By choosing VIVOTEK solutions, users can experience not only high-quality products, but also safer network environments.



VIVOCLOUD App & Portal for 24/7 Viewing

The free VIVOCLOUD app makes surveillance lightweight and portable, ensuring efficient operation. The latest P2P technology makes remote access even more convenient, by simply scanning the QR-code and installing the app, users can view live streams and play recorded clips with the intuitive interface anytime, anywhere. Armed with the Push Notification function, users will directly get an alert message on their Android/iOS mobile device and directly playback the video to check for any suspicious activity.

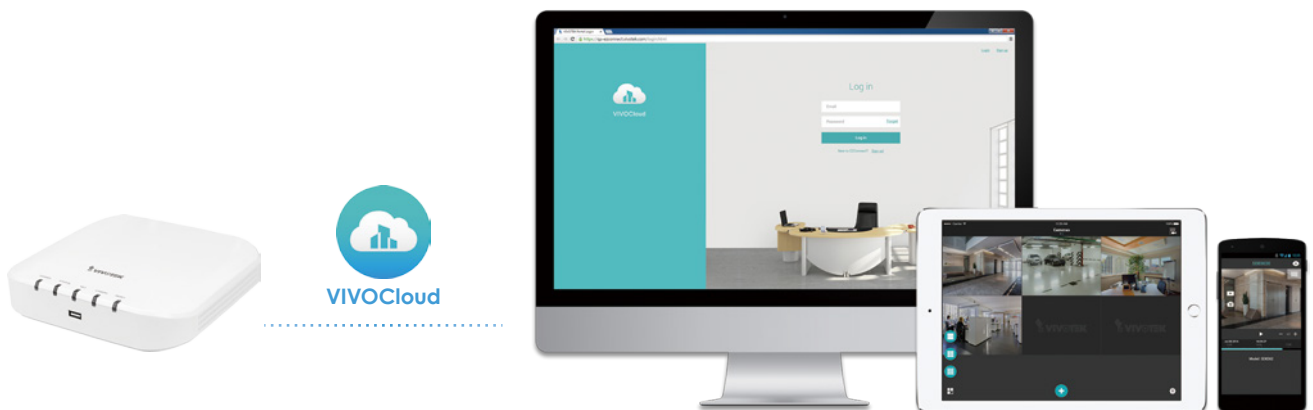

Highlight Features

Easy Connection with IP Cameras and Quick Auto Setup

In order to provide users a highly intuitive experience, it allows for the IP cameras' positions and connects to the NVR without entering long passphrases. Auto Setup Wizard then conveniently sets up a centralized configuration to reduce connection times to within 2 minutes.

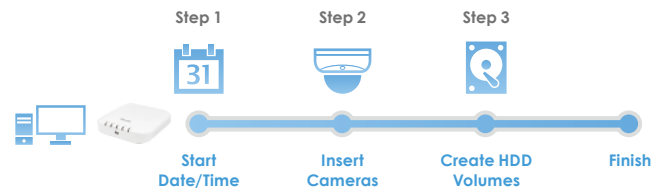

System Structure

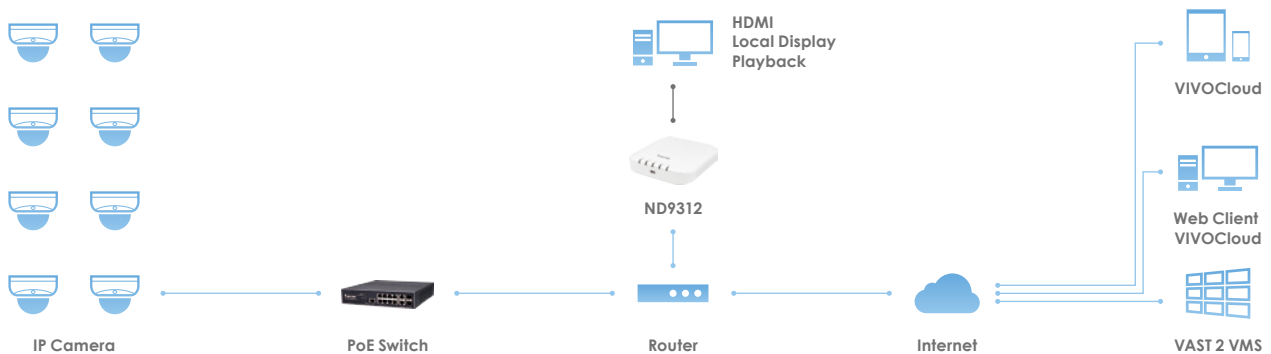

Technical Specifications

Model	ND9312
Device	
OS	Embedded Linux
CPU	ARM Processor
Flash	256 MB
RAM	1GB
Watchdog	Hardware + Software
Power Restoration	System restart automatically after power recovery
Local Display	
Live View Display	8 Channels Multi-layout display: 1x1, 3V, 2x2, 3x3, 1P+3, 2P+3, 1M+5, 1P+6

Technical Specifications

Video Output	HDMI x1
Display Resolution	3840x2160,1920x1080, 1280x720
Camera Position	Change the viewcell position on the live view screens
Stream Application	Constant\Auto adaptive stream
Monitor Enhancement	OSD display (NVR), OSD display (camera), camera information, remote I/O control, event notification, aspect ratio
Fisheye Dewarp	10, 1P, 1R, 103R, 108R
PTZ Operation	Direction control, home, iris, preset, patrol (group), PiP control

Video

Video Format	H.265, H.264, MJPEG
Graphic Decoder	Hardware decoding
Decoding Resolution	Up to 3840x2160
Decoding Capability	3840x2160 @ 30 fps (1CH) 1920x1080 @ 120 fps (4CH) 1280x720 @ 240 fps (8CH)

Audio

Audio Format	G.711, G.726
Audio In/Out	HDMI with audio out

Record

Recording Time (sec.)	Pre-Record: 5 (Max. 10) Post-Record: 20 (Max. 300)
Recording Stream	Single
Recording Throughput	48 Mbps
Recording Mode	Continuous, schedule, manual, event, activity adaptive streaming
Recording Setting	Recycle (unit: day)
Watermark	Supported

Storage & Backup

HDD Devices	Internal x1 (3.5")
HDD Max. Capacity	* Please refer to HDD supported list on the VIVOTEK website.
Disk Management	Create, format and remove disk HDD S.M.A.R.T.
Video Clip Export	USB dongle (FAT format)
Schedule Backup	FTP

Playback

Playback Display	4 Channels Multi-layout display: 1x1,2x2,1P+3,1V+3
Playback Control	Regular (play, pause, stop), rewind, next /previous frame, speed control, calendar, event, timeline, timeline scale, thumbnail (storyboard)

Technical Specifications

Video Search	By calendar, date/time, alarm
Thumbnail Explorer (Storyboard)	Listing the thumbnail of recorded video (Max. 2 CH)
Snapshot	JPEG
Video Clip Export	EXE
Network	
Ethernet	10/100Mbps Ethernet (RJ-45) x 1
Video Throughput for Remote Client	40 Mbps
Protocols	IPv4, TCP/IP, HTTP, HTTPS, UPnP, RTSP/RTP/RTCP, SMTP, FTP, DHCP, NTP, DNS, DDNS, IP Filter
External Interface	
USB	USB 2.0 x 2 (front x1, back x1)
Audio	HDMI with audio out
System	
Camera Integration	ONVIF Profile S
Event	Motion detection, PIR detection, tampering detection, camera DI/DO, camera disconnected, disk failure, disk full
Event Action	Record, email (text/snapshot), FTP, buzzer, ePTZ control (go to preset), camera DO, send to CMS, VIVOCLOUD APP notification
User Management	User level: administrator, regular user
Log	System, recording, user, error
Date&Time	Time zone, manual, automatic sync NTP, daylight saving time
Language	Czech, English, French, German, Italian, Japanese, Korean, Portuguese, Polish, Russian, Spanish, Simplified Chinese, Traditional Chinese
Advance Features	
Trend Micro IoT Security	Supported
Remote Client	
Software AP	Shepherd, VAST 2
Mobile/Tablet App	iViewer (Android & iOS)
Web Browser	Internet Explorer 10 (32 bit) or later / Windows Chrome v68.0.3 & Firefox v61.0.2 or later / Windows & macOS
VIVOCLOUD	Supported
General	
Power Input	DC 12V 3A
Power Consumption	Max. 15W
Dimensions	198 (W) x 200 (D) x 47(H) mm
Weight	530 g (Without HDD)
Operating Temperature	0°C ~ 40°C (32°F ~ 104°F)

Technical Specifications

Humidity	0 ~ 95%
Safety Certifications	CE, LVD, FCC, VCCI, C-Tick, UL
Warranty	12 months

Dimensions

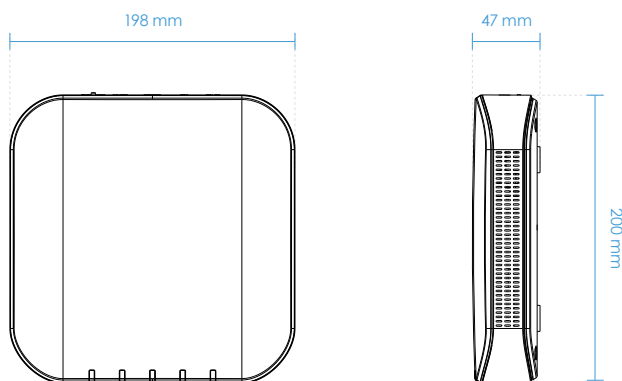

Mechanical Information

Front View

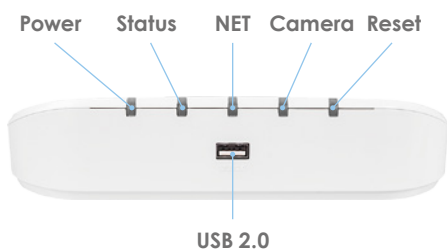

Back View

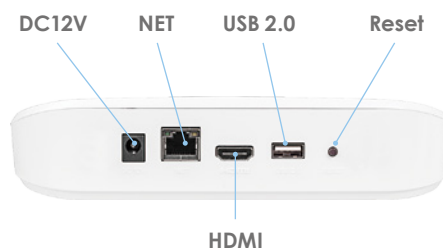

Ordering Information

Model	Description	P/N
ND9312	H.265, 8CH, 1HDD NVR	100218100G, US
		100218110G, EU
		100218120G, UK
		100218130G, AU
		100218140G, JP

AW-FET-060C-065/100C-120 AW-FGT-100C-120/180C-250 AW-FGT-260C-380

FE Unmanaged PoE Switch



Extend PoE up to 200M at 10 Mbps • Surge Protection

VIVOTEK's FE unmanaged PoE switches equipped with DIP switch provides ST Standard and EX Extend operational modes. They are specially designed for IP Surveillance applications. Besides standard 802.3af/at PoE functions in ST mode, the EX mode also transmits data & power on one single cable up to 200 meters at 10 Mbps via specific EX ports for long reach PoE IP cameras. VIVOTEK's FE unmanaged PoE switches also feature adding an additional 10% range of input voltage tolerance (280VAC 4hr, 300VAC 1min), lightning surge protection of AC power & PoE

surge protection to prevent damage caused by outside unstable AC power, lightning strikes and power spikes. These unique features help to reduce the costs of replacing damaged units.

VIVOTEK's FE unmanaged PoE switches provide five sub models consisting of 6, 10, 10,18 and 26 ports with a range of power budgets from 60W to 370W for IP surveillance applications.

Key Features

- 15.4W/30W 802.3af/802.3at compliant
- 4KV PoE surge protection each port(AW-FET-060C-065/AW-FET-100C-120/AW-FGT-100C-120)
- 12KV PoE surge protection each port(AW-FGT-180C-250/AW-FGT-260C-380)
- 4KV AC surge protection
- 20% range of input voltage tolerance (280VAC 4Hr, 300VAC 1min)
- Circuit protection prevents power interference between ports
- Detects PoE PD (power device) automatically
- ST mode reaches PoE camera up to 100M @ 100Mbps via any PoE port
- EX mode reaches 802.3at camera up to 200M @ 10Mbps via EX PoE ports

• ST Mode

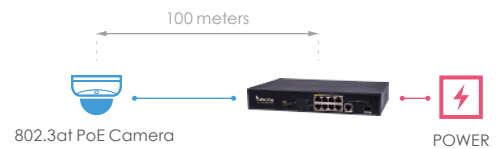



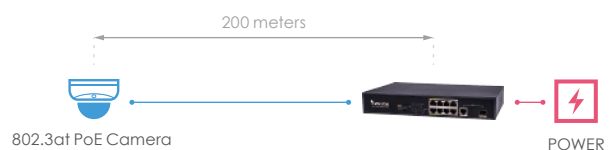

• EX Mode



Range Guide	EX Port @ EX Mode	Any Port @ ST Mode
802.3at PoE IP Camera	200M @ 10Mbps	100M @ 100Mbps

Technical Specifications

Model	AW-FET-060C-065	AW-FET-100C-120	AW-FGT-100C-120	AW-FGT-180C-250	AW-FGT-260C-380
					
Short Highlight	4xFE PoE + 2xFE UTP	8xFE PoE + 2xFE UTP	8xFE PoE + 1xGE UTP + 1xGE SFP	16xFE PoE + 2xGE Combo	24xFE PoE + 2xGE Combo
Networking Specifications					
10/100 Mbps RJ45 PoE Port	4	8	8	16	24
10/100 Mbps RJ45 Port	2	2	-	-	-
10/100/1000 Mbps RJ45 Port	-	-	1	-	-
Gigabit SFP Slot	-	-	1	-	-
Gigabit RJ45/SFP Combo Ports	-	-	-	2	2
EX Mode PoE (200M@10Mbps)*	2	2	2	8	8
VLAN Mode	-	Supported	Supported	-	-
Ethernet Performance					
Switching Capacity	1.2 Gbps	2 Gbps	5.6 Gbps	7.2 Gbps	8.8 Gbps
Mac Table	2 K	2 K	4 K	16 K	16 K
Jumbo Frame			1536 Bytes		
Auto-MDI/MDI-X, Auto-Negotiation			Supported		
Power Specifications					
Power Input Voltage	100VAC ~ 240VAC				
Max. PoE Output Power	Per Port 54VDC, Max. 30W				
Total PoE Power Budget	60W	120W	120W	240W	370W
IEEE 802.3af/at	Supported				
Power Pin Assignment	1/2(+), 3/6(-)				
PoE PD Auto Detection	Supported				
Surge Protection/Each PoE Port	4 KV	4 KV	4 KV	12 KV	12 KV
Surge Protection for AC Power	4 KV				
General					
Operating Temperature	0°C ~ 50°C (32°F ~ 122°F)				
Storage Temperature	-20°C ~ 70°C (-4°F ~ 158°F)				
Operating Humidity	10% ~ 90% non-condensing				
Dimensions	168 (L) x 94.1 (W) x 32 (H) mm	220 (L) x 150 (W) x 44 (H) mm	280 (L) x 180 (W) x 44 (H) mm	440 (L) x 200 (W) x 44 (H) mm	440 (L) x 200 (W) x 44 (H) mm
Weight	0.5 KG	1.2 KG	1.54 KG	3.6 KG	3.8 KG

Technical Specifications

Model	AW-FET-060C-065	AW-FET-100C-120	AW-FGT-100C-120	AW-FGT-180C-250	AW-FGT-260C-380
-------	-----------------	-----------------	-----------------	-----------------	-----------------



Certifications

EMC CE, FCC, VCCI, C-Tick Class A

Safety EN60950-1, IEC60950-1

Dimensions

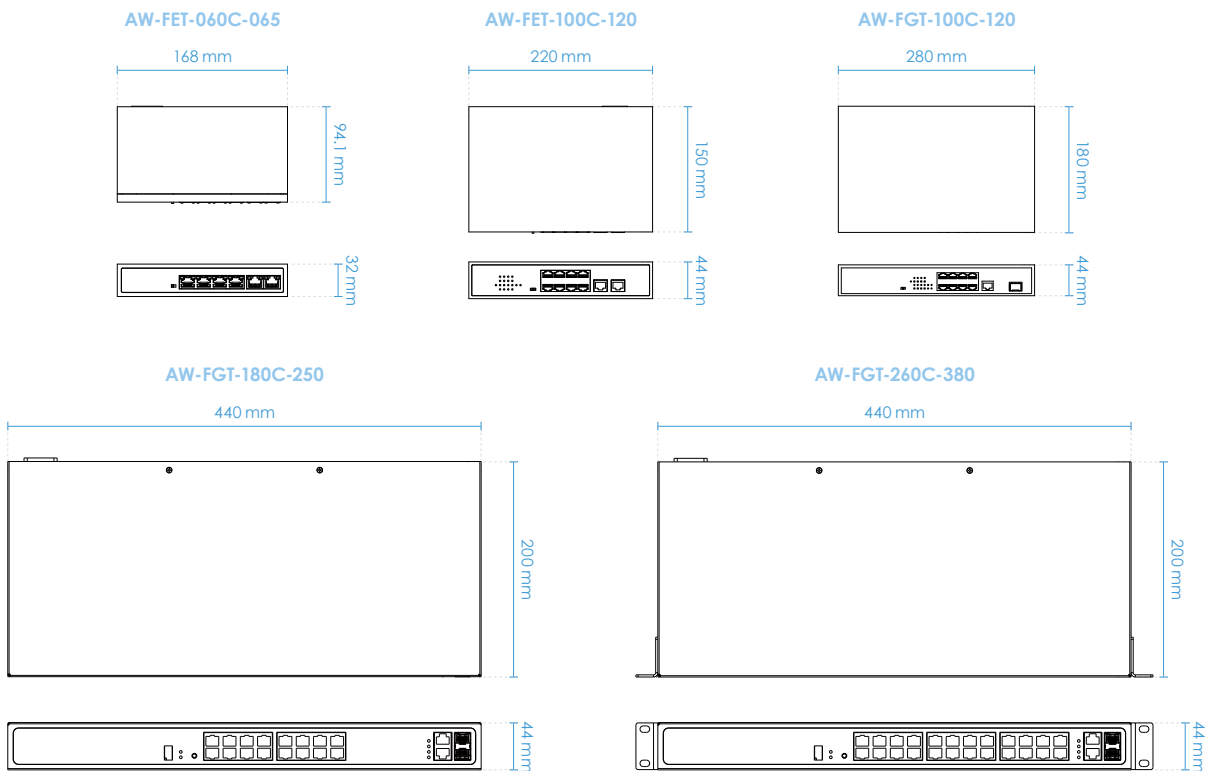

- * EX Mode:
1. CAT.6 or better UTP/STP cable is highly recommended.
 2. Low quality cables will seriously limit the cabling distance.
 3. Ex mode doesn't support with the FE8391-V model.



FD9360-H

Fixed Dome Network Camera



2MP • SNV • WDR Pro • Smart IR • 30M IR •
Smart Stream III • IP66

VIVOTEK's FD9360-H is a H.265 outdoor dome network camera equipped with a 2-Megapixel sensor, enabling resolution of 1920x1080 at 30 fps. Featuring VIVOTEK SNV and WDR Pro technology, the FD9360-H is capable of capturing high-quality imagery in both high contrast and low light environments.

The FD9360-H deploys a 2.8mm/3.6mm lens and is equipped with IR illuminators with a 30-meter effective range for better night visibility. Further, to provide reliable coverage in harsh outdoor environments, the FD9360-H is encased in IP66 and IK10 housing.

By employing VIVOTEK's Smart Stream III technology and H.265 codec support, the FD9360-H is able to reduce bandwidth usage by up to 90%* while maintaining supreme image quality. Additionally, the VADP (VIVOTEK Application Development Platform) allows users to customize applications for the ever-expanding number of user scenarios in a diversifying surveillance market.

* Depending on scenes

Key Features

- H.265 Compression Technology
- 30 fps @ 1920x1080 (WDR Pro on)
- SNV (Supreme Night Visibility) for Low Light Conditions
- WDR Pro for Unparalleled Visibility in Extremely Bright and Dark Environments
- Smart Stream III to Optimize Bandwidth Efficiency
- Built-in IR Illuminators, Effective up to 30 Meters
- Trend Micro IoT Security
- Weather-proof IP66-rated and Vandal-proof IK10-rated Housing
- Built-in MicroSD/SDHC/SDXC Card Slot for On-board Storage



Without WDR Pro

With WDR Pro

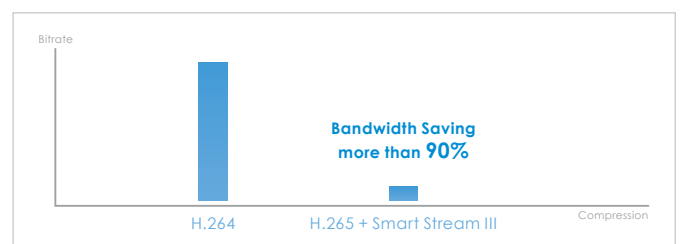

H.265 + Smart Stream III, Ultra-low Bandwidth

Technical Specifications

Model	FD9360-H (2.8mm) FD9360-H (3.6mm)
-------	--------------------------------------

System Information

CPU	Multimedia SoC (System-on-Chip)
Flash	128MB
RAM	256MB

Camera Features

Image Sensor	1/2.9" Progressive CMOS
Max. Resolution	1920x1080 (2MP)
Lens Type	Fixed-focal
Focal Length	FD9360-H(2.8mm): f = 2.8 mm FD9360-H(3.6mm): f = 3.6 mm
Aperture	F2.0
Iris type	Fixed-iris
Field of View	FD9360-H(2.8mm): 109° (Horizontal) 59° (Vertical) 129° (Diagonal) FD9360-H(3.6mm): 81° (Horizontal) 44° (Vertical) 95° (Diagonal)
Shutter Time	1/5 sec. to 1/32,000 sec.
WDR Technology	WDR Pro
Day/Night	Yes
Removable IR-cut filter	Yes
IR Illuminators	Built-in IR Illuminators up to 30 meters with Smart IR, IR LED*2
Minimum Illumination	0,065 lux @ F2.0 (Color) <0,005 lux @ F2.0 (B/W) 0 Lux with IR illumination on
Pan Range	350°
Tilt Range	75°
Rotation Range	350°
Pan/Tilt/Zoom Functionalities	ePTZ: 48x digital zoom (4x on IE plug-in, 12x built-in)
On-board Storage	Slot type: MicroSD/SDHC/SDXC card slot Seamless Recording

Video

Compression	H.265, H.264, MJPEG
Maximum Frame Rate	30 fps @ 1920x1080
Maximum Streams	3 simultaneous streams
S/N Ratio	FD9360-H(2.8mm): 68dB FD9360-H(3.6mm): 68dB
Dynamic Range	120 dB

Video Streaming	Adjustable resolution, quality and bitrate, Smart Stream III
-----------------	---

Image Settings	Time stamp, text overlay, flip & mirror; Configurable brightness, contrast, saturation, sharpness, white balance, exposure control, gain, backlight compensation, privacy masks; Scheduled profile settings, HLC, defog, 3DNR, video rotation
----------------	---

Network

Users	Live viewing for up to 10 clients
Protocols	802.1X, ARP, CIFS/SMB, CoS, DDNS, DHCP, DNS, FTP, HTTP, HTTPS, ICMP, IGMP, IPv4, IPv6, NTP, PPPoE, QoS, RTSP/RTP/RTCP, SMTP, SNMP, SSL, TCP/IP, TLS, UDP, UPnP
Interface	10 Base-T/100 Base-TX Ethernet (RJ-45) *It is highly recommended to use standard CAT5e & CAT6 cables which are compliant with the 3P/ETL standard.
ONVIF	Supported, specification available at www.onvif.org

Intelligent Video

Video Motion Detection	Five-window video motion detection
VADP Package	Trend Micro IoT Security, Stratocast

Alarm and Event

Alarm Triggers	Motion detection, periodical trigger, system boot, recording notification, camera tampering detection, manual trigger, SD card life expectancy, cybersecurity events (brute force attack event, cyberattack event, quarantine event)
Alarm Events	Event notification via email, HTTP, FTP, NAS server, SD card File upload via email, HTTP, FTP, NAS server, SD card

General

Connectors	RJ-45 cable connector for Network 10/100 Mbps PoE connection*1
LED Indicator	System power and status indicator
Power Input	IEEE 802.3af PoE Class 2
Power Consumption	Max. 6.49 W (IR on) Max. 3.69 W (IR off)
Dimensions	Ø 117.2 x 89.6 mm
Weight	540 g
Casing	IP66, IK10(Housing)
Safety Certifications	CE, FCC Class B, UL, LVD, VCCI, C-Tick
Operating Temperature	Starting Temperature: -10°C ~ 60°C (14°F ~ 140°F) Working Temperature: -30°C ~ 60°C (-22°F ~ 140°F)
Humidity	90%
Warranty	24 months

Technical Specifications

System Requirements

Operating System	Microsoft Windows 8/7 Mac 10.12 (Chrome only)
Web Browser	Chrome 58.0 or above Internet Explorer 10/11
Other Players	VLC: 1.1.11 or above QuickTime: 7 or above

Included Accessories

Others	Quick installation guide, alignment sticker, screw pack, cable gland
--------	---

Dimensions

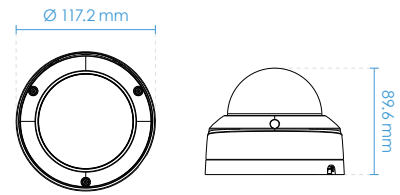

Compatible Accessories

Mounting Kits



AM-21A (V02)
L-shape Bracket



AM-51G
Adapting Plate



AM-52E
Mounting Adapter



AM-71B
Outdoor Conduit Box