

Quick Installation Guide

INTRODUCTION

Model	Power Source	Description
AP-FEX-0105-R	DC	EPoC DC in Rx Module, 1x BNC, 1x FE RJ45, 1 DC Jack, -20°C~60°C
AP-FEX-0105-T	DC	EPoC DC in Tx Module, 1x BNC, 1x FE RJ45, 1 DC Jack, -20°C~60°C
AP-FEX-0100-R	PoE	EPoC PoE in Rx Module, 1x BNC, 1x FE RJ45, -20°C~60°C
AP-FEX-0200-T	DC	EPoC DC in Tx Module, 1x BNC, 2x FE RJ45, 1 DC Jack, -20°C~60°C

PACKAGE CONTENTS

* 1x Quick Installation Guide	* 1x AA-420 power (AP-FEX-0105-R only)
-------------------------------	--

⚠ IMPORTANT:

1. Use CAT5e or CAT6 UTP/STP cables and RG6 coaxial cables.
2. Please avoid using low quality cables, which will seriously limit the cabling distance and power delivery.
3. Make sure the power source is sufficient for your configuration.

CONNECTION

DC input



PoE input

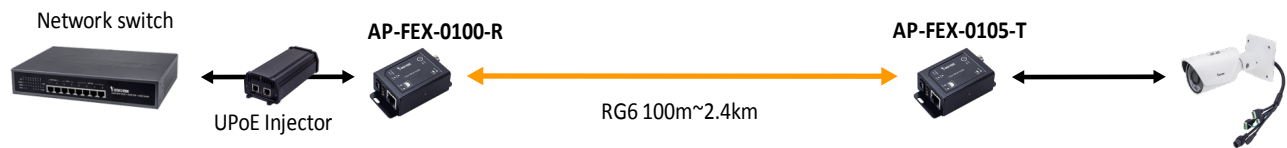

UPoE switch

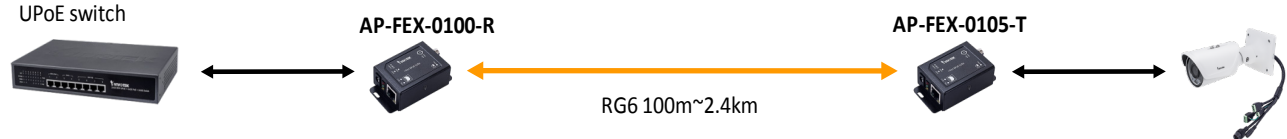

DC input

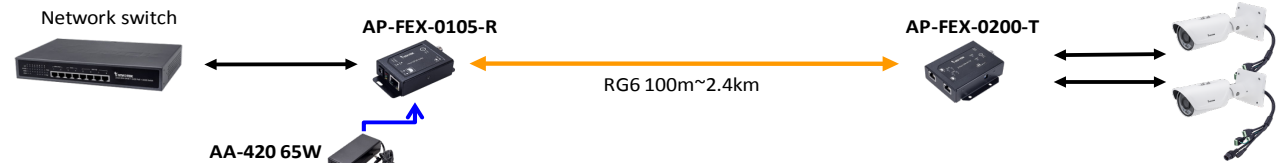

PoE input

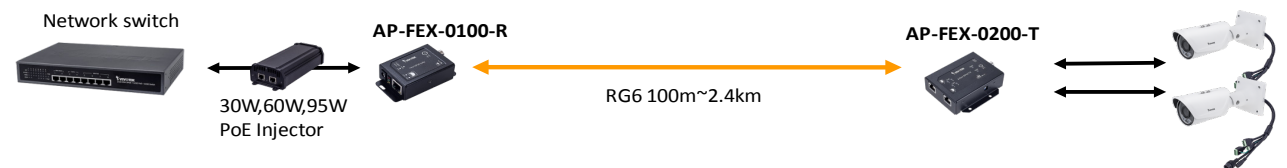

30W, 60W PoE switch

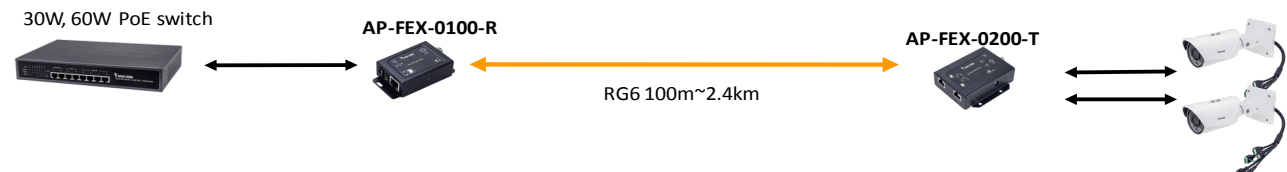

Daisy Chain

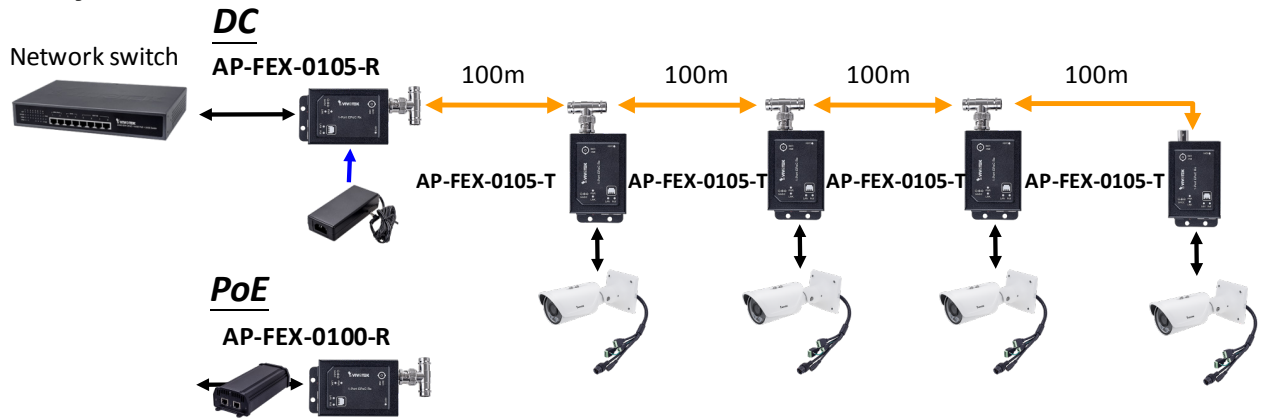

Ring

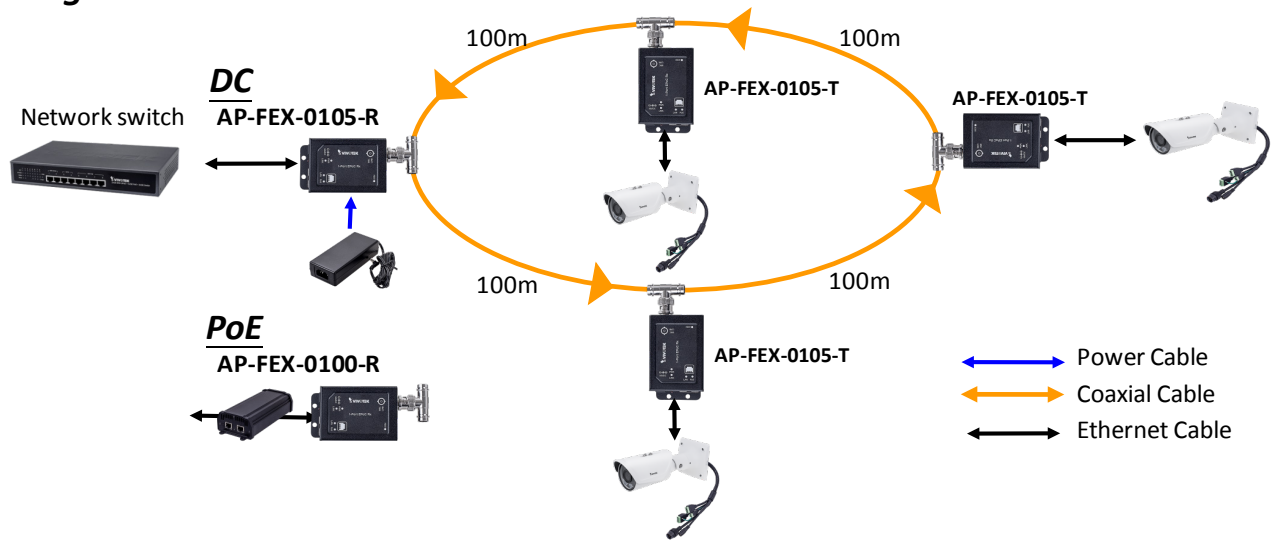

RACKMOUNT INSTALLATION

AP-FEX-0105-R & AA-420

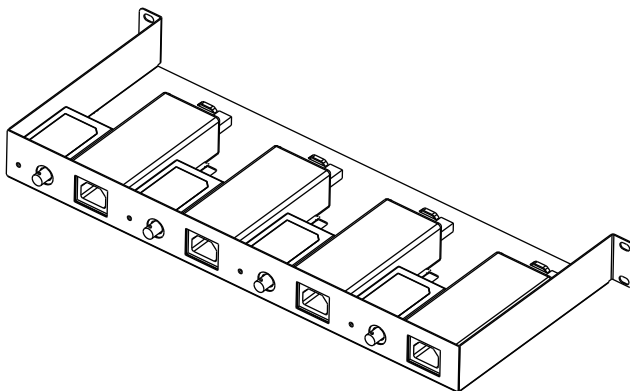

AP-FEX-0100-R

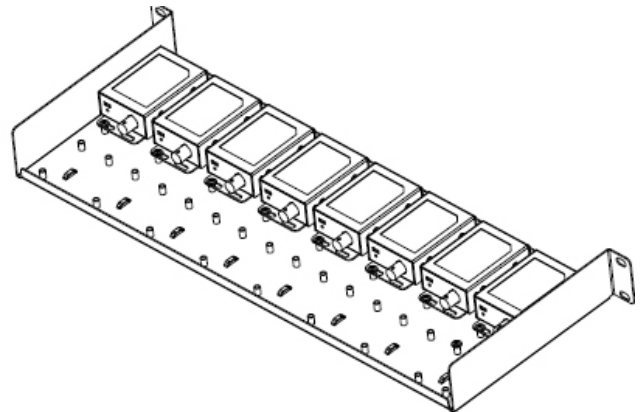

Distance/Power Chart

AP-FEX-0105-T		
Length of Coaxial Cable	AA-420 65W	AP-GIC-011A-095 95W
300m	26.4W	26.4W
500m	17.48W	17.48W
800m	12.63W	12.63W
1000m	8.84W	8.84W
1200m	8.48W	8.48W
1200m ~ 2400m	Data only (100Mbps)	Data only (100Mbps)

AP-FEX-0200-T		
Length of Coaxial Cable	AA-420 65W	AP-GIC-011A-095 95W
100m	20W per port	20W per port
300m	12W per port	12W per port
500m	8W per port	8W per port
500m ~ 2400m	Data only (100Mbps)	Data only (100Mbps)

NOTE:

1. The numbers comply using RG6 coaxial cables.
2. The length of network cable for camera connection is 100m CAT5e cable.
3. The power delivery will vary on the quality of coaxial cable due to resistance.

LEDs

RJ45	Yellow ON	PoE: port is supplying power to PD
	Green flash	LAN: Data is being transmitted or received.
	OFF	No connection
PWR	Green ON	Power is supplied
LINK	Green ON	Rx and Tx EPoC module is connected.

DIP Switch

NOTE: The PoE On/Off switch is only available on AP-FEX-0105-T/AP-FEX-0200-T

DIP#	On	Delivery PoE output to PD device
	Off	No PoE output to PD device

All specifications are subject to change without notice.
Copyright © 2018 VIVOTEK INC. All rights reserved.